

Modular Explosion Proof Brakes

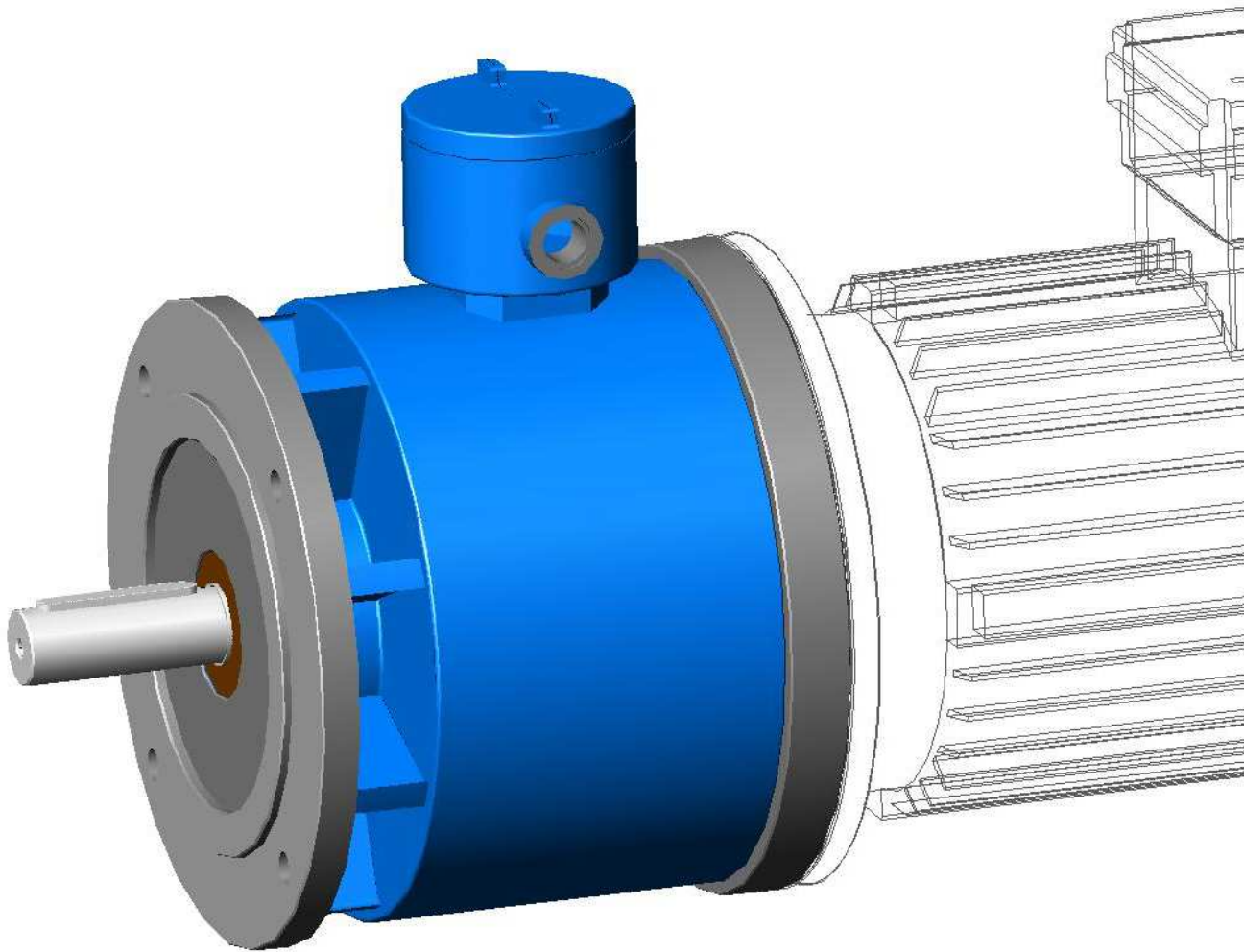

IECLine



A close-up photograph of a blue industrial machine component, likely a valve or actuator. The component has a textured surface and several circular ports. The word "INDEX" is printed in white, bold, uppercase letters in the upper center of the image.

INDEX

PAGE 1

About VIS

PAGE 2

Application example, Main characteristics, Standards

PAGE 3

Certificates and available protection classes

PAGE 4

Identification and options

PAGE 5

Technical data - performance and options

PAGE 6

Technical data, Brake choice

PAGE 7

Technical data - Brake choice

PAGE 8

Overall Dimensions

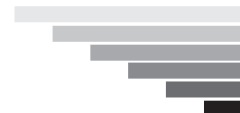

Application example

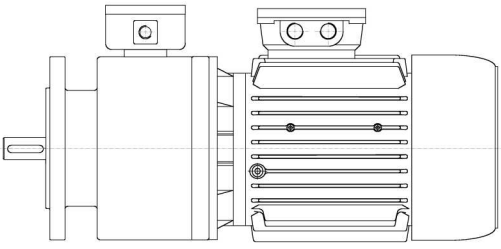

Standard B5 motor + VIS brake

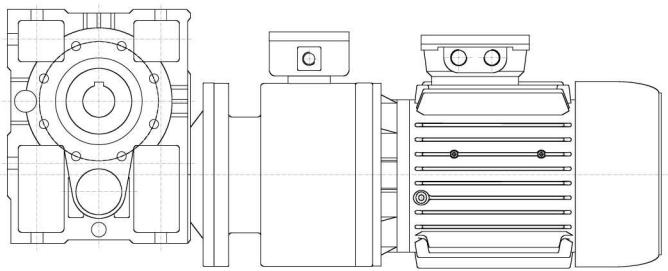

Standard B5 motor + VIS brake + gearbox unit

Main Characteristics

- PATENT pending design and concept system
- Three phase AC (IEC 80 to 160) or single phase DC electromagnets
- Totally closed
- IP66
- Power supply VAC24 to 690 50-60Hz three phase or VDC 24 to 300.
- F class insulation
- Thermally protected with dual metal protectors as standard
- Large terminal box with terminal board and fitted in rectifier (DC only)
- Very high resistance structure
- Designed for S1 duty without ventilation

Standards

The VIS series brakes are designed and approved for the following directives:

- ATEX Directive ATEX 94/9/CE-ATEX 95, Group II 2GD category - Group I M2 category, in compliance with the norms EN 60079-1:2007, EN 60079-0:2009, EN 60079-31:2009
CERTIFICATE **INERIS06 ATEX 0047 additions 01,02,03,04,05**
- INMETRO Directive ABNT NBR IEC 60079-0:2008 ABNT NBR IEC 60079-1:2009
CERTIFICATE **NCC Certificado N° NCC 11.0574 X**
- IEC Ex Directive IEC 60079-0 : 2007-10 IEC 60079-1 : 2007-04 IEC 60079-31 : 2008 Groups I, II, III
CERTIFICATE **IECEX INE 11.0037X**

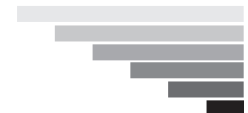

Certificates and available protection classes

For each certification of VIS brakes there are different protection levels available as follows



GAS
II 2 G Ex d II P 1 T P 2 Gb Tamb. : -50°C ÷ +55(for T5 Tamb: +60°C) or -20°C ÷ +55(for T5 Tamb: +60°C).

DUSTS
II 2 D Ex tb IIIC T P 3 Db IP66 Tamb. : -50°C ÷ +55(for classe T100°C Tamb: +60°C) or -20°C ÷ +55(for class T100°C Tamb: +60°C).

GAS and DUST
II 2 GD Ex d II P 1 T P 2 Gb
Ex tb IIIC T P 3 Db IP66
Tamb. : -50°C ÷ +55(for class T5 or T100°C Tamb: +60°C) or -20°C ÷ +55(for class T5 or T100°C Tamb: +60°C).

I M2 Ex d I Mb Tamb. : -50°C ÷ +55°C oppure -20°C ÷ +55°C

Pn are subjected to the following variations:

P1 for GAS groups if:
- P1 = B : gas group IIB.
- P1 = C : gas group IIC.

P2/P3 for temperature classes/surface temperature:
- P2 = T3 P3 = T200°C
- P2 = T4 P3 = T135°C
- P2 = T5 P3 = T100°C

- 50°C ÷ + 55°C (for class T5 o T100°C Tamb: +60°C) = Amb Temp.
- 20°C ÷ + 55°C (for class T5 o T100°C Tamb: +60°C)= Amb temp for frames 250/280

T.cable : 80°C= Cable temperature



- » Category: 2G / 2D /2GD
- » Type of protection: Ex d / Ex tD A21
- » Enclosure group: II B / II C
- » Temperature class: T3 / T4 / T5
- » Maximum surface temperature: T200°C / T135°C / T100°C
- » Protection mode: IP66
- » Ambient temperature -50°C +55°C (available as option on frames 63 to 225) or -20 +55°C (standard for frames 63 to 280)



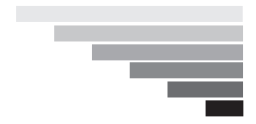

Options

- Hand release (not available for IEC frames 250 and 280)
- Ready for hand release kit
- PTC thermistors
- Anti condensation heaters
- Switch on brake opening or on hand release
- Special flange coupling

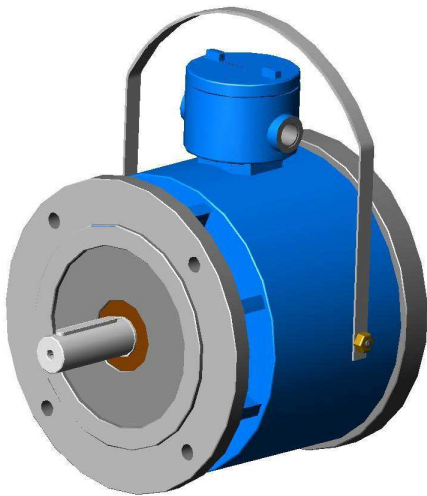

Hand release

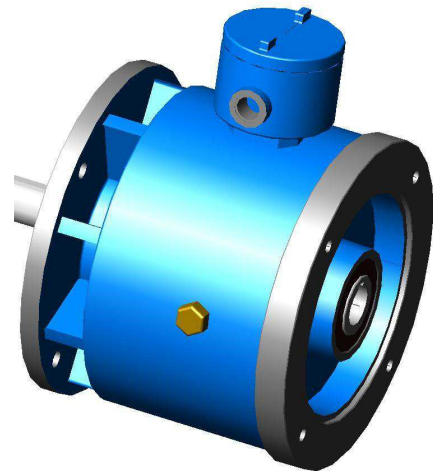

Hand release ready

Ordering a VIS brake

For ordering a VIS brake it's necessary to supply the following information:

- 1) Type of certification required and protection classes needed
- 2) Input and output flange / shafts dimensions
- 3) If AC or DC
- 4) Voltage needed
- 5) Brake torque required
- 6) Options required

All the brakes are available in different voltages and brake torque values

Please see the performance data in order to correctly identify the brake



Technical data

General information

The spring-applied brake VIS is a single-disk brake with two friction surfaces.

The compression springs create the braking torque by friction locking. The brake is released electromagnetically.

The spring-applied brake is designed for the conversion of mechanical work and kinetic energy in heating. For operation characteristics see related paragraph.

Manual release (not applicable for IEC 250 and 280)

The manual release is an option available, it gives the possibility to release the brake in absence of current. It is a mechanical lever mounted on 2 fulcrums points moving the mobile anchor.

Microswitch

The VIS brakes can be equipped with a microswitch for air-gap or wear monitoring or for hand release opening monitoring. The user must provide the corresponding electrical connection.

Thermistors

All the VIS brakes are equipped with a PTO thermal protection with temperature limit related to the temperature class of the brake required. It must always be connected when operating in order to prevent extra heating in hazardous areas.

In alternative, we can apply a PTC thermistor to have a constant monitoring of the brake temperature through an external PLC.

Performance Data (IEC version)

| FRAME | Nm (min\max) | W (DC) | VA AC (3ph) | Engagement time (ms) | | Braking time [ms] | | | Maximim RPM | |
|---------|-----------------|-----------|-------------------|----------------------|------|-------------------|--------------|---------------|-------------|---------|
| | | | | AC 3 PH. | DC | DC Brake | | AC 3 Phase | Duty S1 | Duty S3 |
| | | | | Type | Type | DC Switching | AC Switching | | | |
| 71 | 3\8 | 40 | na | / | 12 | 20 | 120 | / | 3600 | 4320 |
| 80-90 | 12\22 | 50 | 100 | 18 | 20* | 40 | 240 | 8 | 3600 | 4320 |
| 100 | 20\40 | 80 | 240 | 18 | 25* | 90 | 540 | 9 | 3600 | 4000 |
| 112 | 30\60 | 80 | 240 | 18 | 25* | 90 | 540 | 9 | 3600 | 4000 |
| 132 | 70\150 | 105 | 320 | 23 | 30* | 180 | 1080 | 12 | 3600 | 4000 |
| 160 | 100\160 | 105 | 320 | 23 | 30* | 180 | 1080 | 12 | 2800 | 2900 |
| 180 | 180\335 | 180 | na | / | 90* | 230 | 2300 | / | 2500 | 2800 |
| 200-225 | 300\460 | 180 | na | / | 90* | 230 | 2300 | / | 2500 | 2800 |
| 250 | 700\1000 | 210 | na | / | 160* | 360 | 3800 | / | 1800 | 2200 |
| 280 | 700\1200 | 210 | na | / | 160* | 360 | 3800 | / | 1800 | 2200 |

* values obtained with rectifier type WR2008



Technical data

Loads

IEC VIS brakes line is designed to be mounted in front of a flanged motor; the bearing used in the input shaft has the only function to support the coupling between the motor and brake shafts and cannot be subjected to additional axial or radial loads. The output shaft admissible radial loads of IEC VIS brakes line are described in the following tab.

| Frame | N | Load at shaft center |
|---------|------|----------------------|
| 63-71 | 250 | |
| 80-90 | 380 | |
| 100-112 | 550 | |
| 132-160 | 790 | |
| 180-225 | 1700 | |
| 250-280 | 3400 | |

Braking time

VIS brakes are suitable for application with disk sliding of the disk of 0,5 seconds maximum. In case of longer time of sliding of the disk calculation, please contact us.

You can use the following formula in order to define the braking time:

$$\frac{J_{tot} \times n}{9.55 (M_f \pm M_{load})} + \frac{t_x}{1000}$$

J_{tot}: inertia moment at the motor shaft (Kgm²)
n: speed r.p.m.
M_f: braking moment (Nm)
t_x: brake time response (ms)
M_{load}: resistant moment to the load applied (Nm), positive or negative depending on concordance with braking moment.

Note: for calculation of sliding time of the disc, consider the “t_x” value at “0” .

Brake choice

AC or DC?

When you choose a VIS brake, it is important to define which version is better suitable for your application and/or for your electrical equipment.

The 3 phase version is very quick both in engagement and braking times, so it is suggested for application where there are high number of cycles per hour.

Since this brake is very quick it also creates more impact vibration in starting and braking operation compared to DC.

The 3 phase brake is suitable to be connected direct on line with the same voltage of the motor you have and without rectifier and it is available with voltages from VAC24 up to VAC690 Hz 50 or 60.

The DC version has a smooth performance, but can also be quick using a special rectifier for fast braking connection cutting the DC current.

It is available from 24 to 300 VDC with rectifier.



■ Brake choice ■

Dimensioning

The size of the brake is mainly determined by the braking torque and the relevant inertia of the load, braking time, speed, number of starts per hour.

The calculation of the brakes is generally related to the permissible friction energy. Since the VIS is an explosion proof unit, we simply defined a limit related to the maximum permissible sliding time of the disc in dynamic application (see page 6 for more details).

This solution gives a simple parameter to choose the brake in a correct, easy and safe way.

If the brake is used as parking brake (coupled with a motor used with inverter), the calculation is not relevant except the value of brake torque necessary; we suggest always to consider a brake torque between 1,5 and 2,3 times the motor torque.

For further information or exact brake calculation choice, please contact us.

Versions

The VIS brakes are available in 3 main construction executions:

- IEC dimension for front mounting on B5 motor and output B5 or B14 or reduced B5
- NEMA dimension for front mounting on nema motor (for dimensions please contact us)
- Closed version for mounting in the rear side of a motor prepared for it.

Except these configurations, we can manufacture customized versions with output flanges and shafts made on specific request.

Voltages

AC 3ph Brakes

The AC 3ph brakes work in star/delta configuration like a common 3ph motor - the standard voltage is 230/400 V 50Hz.

We can produce any AC voltage, 50 or 60 Hz with maximum 600V. The voltage tolerance on the nominal one is +/- 5% on standard brakes. Different tolerance can be supplied on request.

DC Brakes

The DC brakes are supplied as standard rectifier inside the terminal box in order to supply the brake with 2x AC phases. The standard voltage is DC 195 with 400 VAC to the rectifier. We can produce different voltages on request with a maximum of 300VDC coil.

DC brakes are standard supplied with WR2008 half wave rectifier providing fast engagement and braking times.

Different rectifiers can be supplied for special applications.

Overall Dimensions

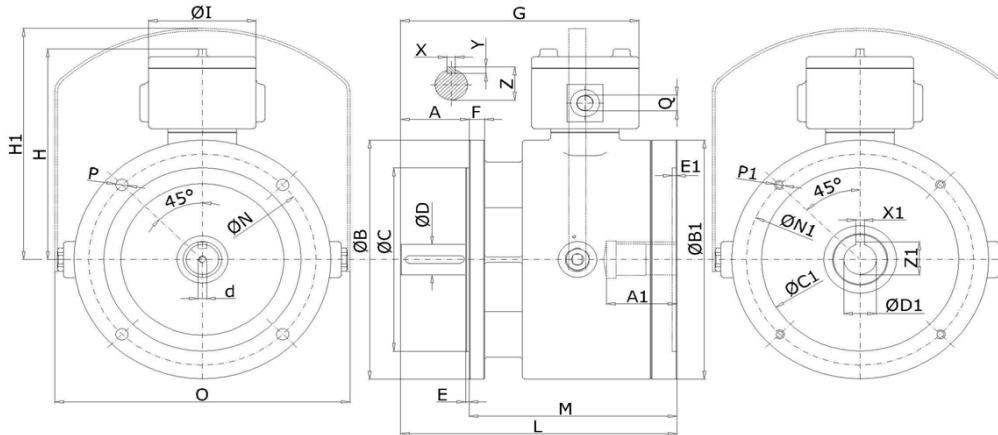

| TYPE B5 | 63 | 71 | 80 | 90 | 100-112 | 132 | 160 | 180 | 200 | 225 | 250 | 280 |
|--------------|-------|-------|--------|--------|---------|--------|--------|--------|--------|---------|---------|---------|
| (Kg) | 15 | 16 | 32 | 34 | 50 | 78 | 82 | 135 | 150 | 175 | 265 | 265 |
| A (+0/-1) | 23 | 30 | 40 | 50 | 60 | 80 | 110 | 110 | 110 | 140 | 140 | 140 |
| A1 | 25 | 31 | 41 | 51 | 61 | 81 | 111 | 111 | 111 | 141 | 141 | 141 |
| B (+/-1) | 140 | 160 | 200 | 200 | 250 | 300 | 350 | 350 | 400 | 448 | 550 | 550 |
| B1 (+/-1) | 140 | 160 | 200 | 200 | 250 | 300 | 350 | 350 | 400 | 450 | 550 | 550 |
| C (h8) | 95 | 110 | 130 | 130 | 180 | 230 | 250 | 250 | 300 | 350 | 450 | 450 |
| C1 (H8) | 95 | 110 | 130 | 130 | 180 | 230 | 250 | 250 | 300 | 350 | 450 | 450 |
| D | 11 j6 | 14 j6 | 19 j6 | 24 j6 | 28 j6 | 38 k6 | 42 k6 | 48 k6 | 55 m6 | 60 m6 | 65 m6 | 75 m6 |
| D1 (E6) | 11 | 14 | 19 | 24 | 28 | 38 | 42 | 48 | 55 | 60 | 65 | 75 |
| d | M4X10 | M4X10 | M6X20 | M6X20 | M8X20 | M10X25 | M10X25 | M20X30 | M20X30 | M20X30 | M20X30 | M20X30 |
| E | 2,5 | 3,5 | 3,5 | 3,5 | 4 | 4 | 5 | 5 | 5 | 5 | 5 | 5 |
| E1 | 4 | 4 | 4,15 | 4,15 | 5 | 5,5 | 5,5 | 6 | 6 | 8 | 8 | 8 |
| F | 10 | 10 | 12 | 12 | 14 | 18 | 18 | 21 | 21 | 21 | 26 | 26 |
| G | 169,5 | 176,5 | 207 | 217 | 236,5 | 277,5 | 309,5 | 366,5 | 366,5 | 396,5 | 378,5 | 378,5 |
| H | 185 | 185 | 215 | 215 | 240 | 265 | 265 | 282 | 282 | 282 | 328 | 328 |
| H1 | 205 | 205 | 230 | 230 | 255 | 290 | 290 | 320 | 320 | 320 | - | - |
| I | 125 | 125 | 125 | 125 | 125 | 125 | 125 | 125 | 125 | 125 | 125 | 125 |
| L | 168 | 175 | 236 | 246 | 276 | 322 | 352 | 410 | 410 | 440 | 450 | 450 |
| M | 145 | 145 | 196 | 196 | 216 | 242 | 242 | 300 | 300 | 300 | 310 | 310 |
| N | 115 | 130 | 165 | 165 | 215 | 265 | 300 | 300 | 350 | 400 | 500 | 500 |
| N1 | 115 | 130 | 165 | 165 | 215 | 265 | 300 | 300 | 350 | 400 | 500 | 500 |
| O | 205 | 205 | 250 | 250 | 305 | 355 | 355 | 370 | 370 | 370 | - | - |
| P | 9,5 | 9,5 | 11,5 | 11,5 | 14,5 | 14,5 | 18 | 18 | 18 | 18 | 18 | 18 |
| P1 | M8X16 | M8X16 | M10X18 | M10X18 | M12X18 | M12X18 | M16X21 | M16 | M16 | n°8XM16 | n°8XM16 | n°8XM16 |
| Q | 1XM20 | 1XM20 | 1XM20 | 1XM20 | 1XM20 | 1XM20 | 1XM20 | 1XM20 | 1XM20 | 1XM20 | 1XM20 | 1XM20 |
| X | 4 | 5 | 6 | 8 | 8 | 10 | 12 | 14 | 16 | 18 | 18 | 20 |
| X1 | 4 | 5 | 6 | 8 | 8 | 10 | 12 | 14 | 16 | 18 | 18 | 20 |
| Y | 4 | 5 | 6 | 7 | 7 | 8 | 8 | 9 | 10 | 11 | 11 | 12 |
| Z | 12,5 | 16 | 21,5 | 27 | 31 | 41 | 45 | 51,5 | 59 | 64 | 69 | 79,5 |
| Z1 (+0,1/-0) | 12,8 | 16,3 | 21,8 | 27,3 | 31,3 | 41,4 | 45,4 | 51,9 | 59,4 | 64,4 | 69,4 | 49,9 |

IT IS POSSIBLE TO SUPPLY VERSIONS WITH B14 OR SPECIAL OUTPUT FLANGE/SHAFT
PLEASE CONTACT US FOR FURTHER DETAILS